

## Maßskizze / dimensional drawing

Benennung: Stecker IP44 Kleinspannung

description: Plug IP44 extra low voltage

Teilenummer / part number: 062\*, 063\*, 072\*, 073\*, 082\*, 083\*, 092\*, 093\*

PCE

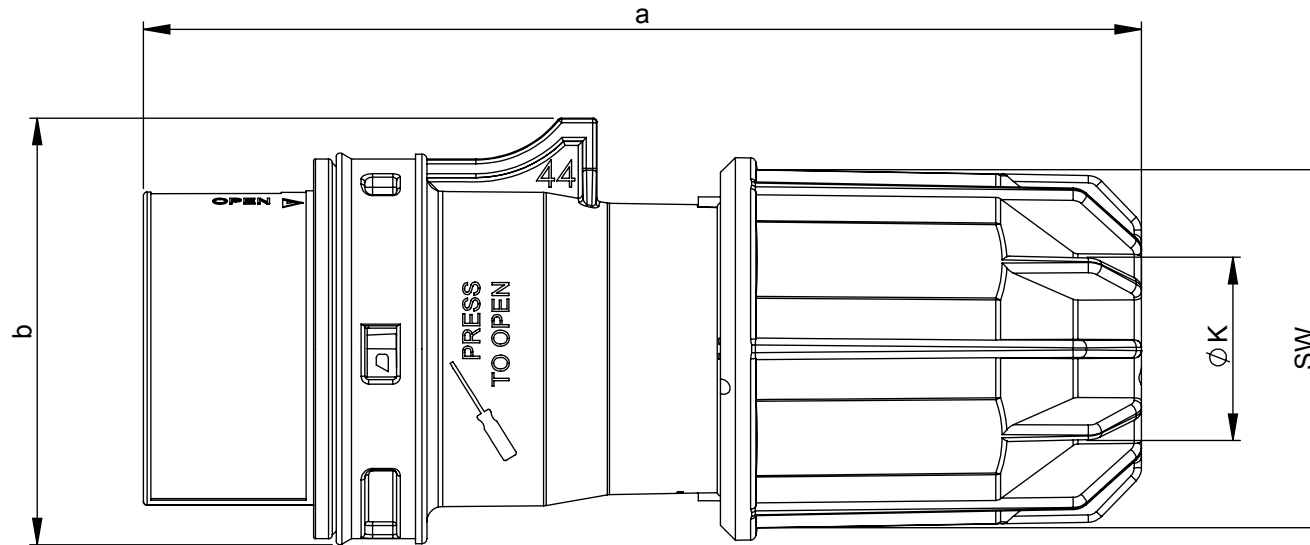

Ampere	16		32	
Pole	2	3	2	3
a [mm]	135	135	135	135
b [mm]	57	57	57	57
K [mm]	9,5-24	9,5-24	9,5-24	9,5-24
SW [mm]	48	48	48	48